

seppi m[®]

MULCHING EQUIPMENT SPECIALISTS

Forestry mulchers

Forestry mulchers



„Mulchers are a long-term investment.
It is important to us that you remain satisfied with your mulcher.“

SEPPI M. SpA

Our commitment

- > Founded in 1939, we have been manufacturing mulchers since 1971
- > Regardless of the manufacturer or brand, we only choose materials and products that meet our rigorous quality criteria
- > Continuous research and development
- > High quality and optimal service

Your advantages

- > Reliable equipment as the result of years of experience in the sector
- > High quality materials to take on the harshest work conditions and guarantee maximum durability
- > Advanced technology for an investment for the future
- > Consulting and after sales service: You can rely on us!

Rotors and hammers



Rotor with swinging hammers

for mulching grass and bushes/branches/wood

- Wear resistant rotor made of tempered steel
- Hammers made of tempered steel available without and with inserts made of tungsten carbide



Rotor with fixed tools

for mulching wood, tilling stumps and for soil cultivation

- Wear resistant rotor made of tempered steel
- Hammers made of wear resistant steel with inserts made of tungsten carbide

A special composition of the tungsten carbide makes the hard metal inserts of SEPPI M. extremely hard and wear-resistant.



SEPPI M.
PATENT



MINI
DUO



MINI
BLADE



MONO
TIP
V-LOCK



SUPER
MONO TIP
PROTECT











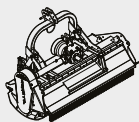



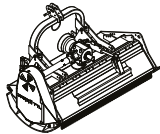



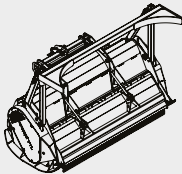

SEPPI M. patented system of tool holders protect the tools and allow an easy replacement for a minimum downtime.

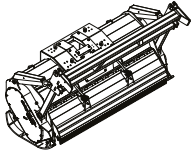
Sustainable forest management with SEppi mulching machines

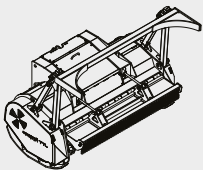
Forestry mulcher for tractors from 80 to 500 HP

for maintenance of woodlands and forests, cleaning after timber felling, building forest roads, skid trails and firebreaks, for maintenance of forest border lines and other forestry operations

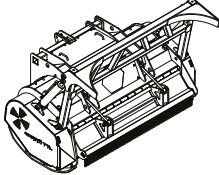

WORKING WIDTH							MODEL · WEIGHT ¹ · POWER	GRASS	BRANCHES	WOOD	STUMP
125	150	175	200	225	250	350					
●	●	●	●				 <p>MINIFORST 60-100 HP 770-1.090 kg [1,700-2,400 lb] max. 20 cm Ø [7.9 inch]</p>	 MIDIFORST-240	 MIDIFORST-193  MINI DUO  MINI BLADE		
			●	●	●		 <p>MIDIFORST 810-130 HP 1.240-1.470 kg [2,730-3,240 lb] max. 25 cm Ø [9.8 inch]</p>	 MIDIFORST-240	 MIDIFORST-193  MINI DUO		
			●	●	●		 <p>MIDIFORST dt 120-190 HP 1.590-2.150 kg [3,510-4,740 lb] max. 30 cm Ø [11.8 inch]</p>	 MIDIFORST-240	 MIDIFORST-193  MINI DUO  MONO TIP V-LOCK		
			●	●	●	210 235 260	 <p>STARFORST 180-300 HP 2.650-3.180 kg [5,840-7,010 lb] max. 40 cm Ø [16 inch]</p>		 MINI DUO  MONO TIP V-LOCK		
			●	●	●		 <p>SUPERFORST 230-390 HP 3.800-4.400 kg [8,380-9,700 lb] max. 50 cm Ø [20 inch]</p>	 SUPERFORST-240	 SUPERFORST-193  MINI DUO  SUPER MONO TIP PROTECT		
					●	●	 <p>MAXIFORST 300-500 HP 4.330-4.960 kg [9,550-10,930 lb] max. 60 cm Ø [24 inch]</p>		 MINI DUO		

¹ standard version without options

MINIFORST

max. 20 cm Ø 60-100 HP

Forestry mulcher for small tractors - versatile in use

MINIFORST is the smallest mulching machine of this series and can be attached to small and medium-sized tractors. It mulches grass and bushes up to 20 cm in diameter. Thanks to the large range of rotors, this mulcher can be adapted for specific work. The standard rotor is equipped with swinging tools, an optional fixed tools rotor is available with tungsten carbide inserts. If required, the mulcher will be delivered with a guard frame.

Standard version and characteristics

- > Mulches bushes and wood up to 20 cm [8"]Ø

- > Working speed 0-5 km/h

- > 3 point rear linkage cat. 2 central fixed

- > 1000 rpm gearbox with freewheel and through shaft

- > Belt transmission

- > Hydraulically operated hood

- > Reinforced skids, adjustable in height

- > Front- and rear protection with chains

- > Tempered counter knives

- > Standard rotor fixed hammers MINI DUO with 2 tungsten carbide inserts

Optional configuration and accessories

- > Fixed tools with knife MINI BLADE

- > Swinging hammers

- > Swinging hammers with 3 tungsten carbide inserts

- > Front attachment

- > 3 point rear linkage cat. 1 and 2

- > 540 rpm gearbox

- > Guard frame



YouTube www.youtube.com/seppimulcher

Specifications · MINIFORST	Tractor 60-100 HP			
	125 cm [49"]	150 cm [59"]	175 cm [69"]	200 cm [79"]
Working width	125 cm [49"]	150 cm [59"]	175 cm [69"]	200 cm [79"]
Overall width	149 cm [59"]	174 cm [69"]	199 cm [78"]	224 cm [88"]
Depth	115 cm [45"]	115 cm [45"]	115 cm [45"]	115 cm [45"]
Height	110 cm [43"]	110 cm [43"]	110 cm [43"]	110 cm [43"]
Weight (base value w/o opt.)	770 kg [1700lb]	880 kg [1950lb]	970 kg [2140lb]	1090 kg [2410lb]
Belts	5	5	5	5
Fixed hammers · standard	27	30	33	36
Fixed tool/knife · OPT-380	27	30	33	36
Swinging hammers · OPT-240	20	24	29	33
Swinging hammers · OPT-193	20	24	29	33

Tools



Fixed hammer
MINI-DUO



Fixed tool/knife
OPT-380
MINI BLADE



Swinging hammer
OPT-240



Swinging hammer
OPT-193

MINIFORST · Characteristics

Smallest forestry mulcher from SEPPI M. in robust construction like the larger machines: with reinforced housing and welded belt protection.

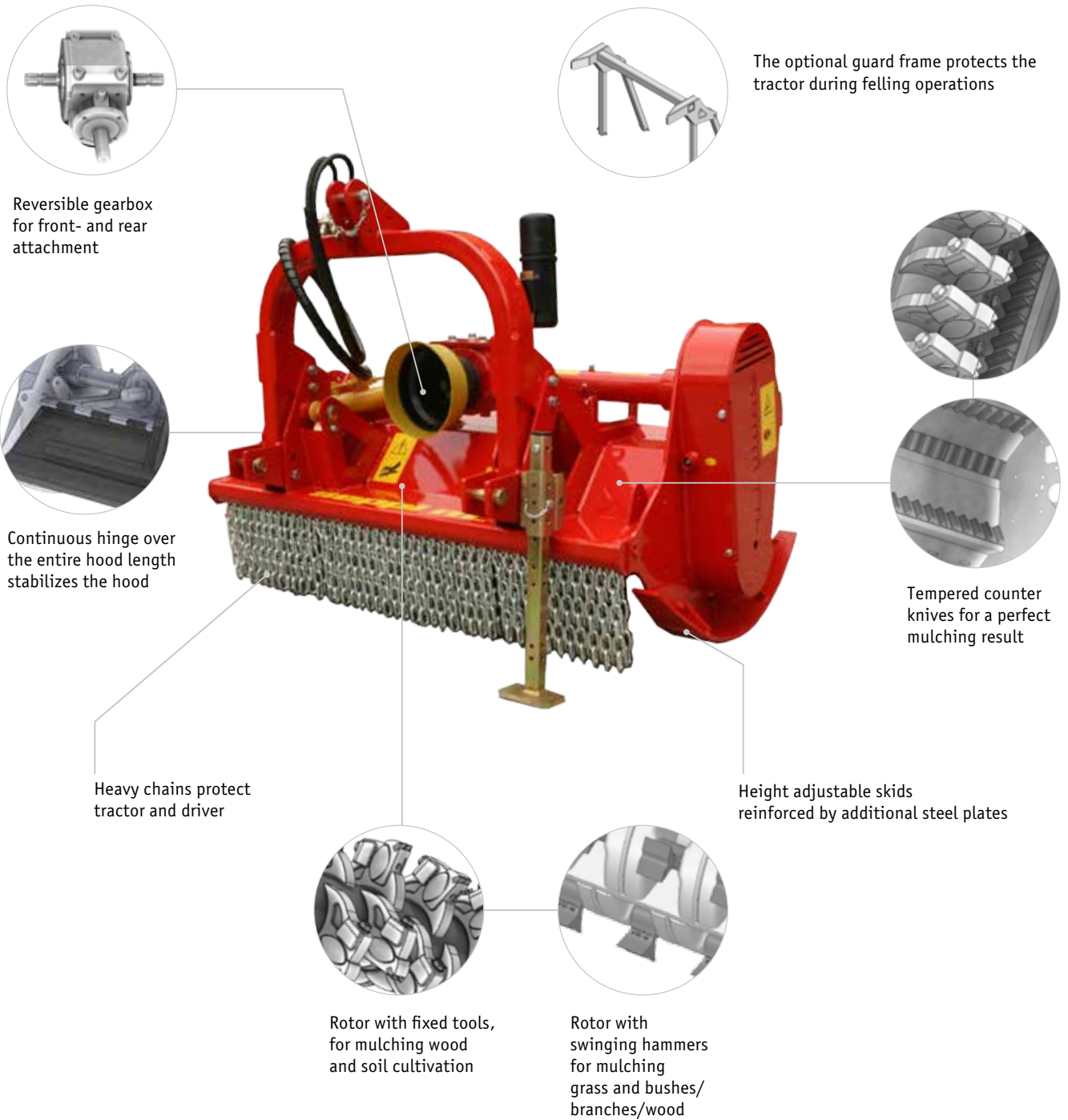

MIDIFORST

max. 25 cm Ø 80-130 HP

Compact forestry mulcher with high performance

The MIDIFORST forestry mulcher is ideal for a wide range of jobs -
in forestry: for the care of wood land and forest paths, electricity and gas pipelines,
cleaning after the harvesting of wood, for the construction of fire breaks ...
and in agriculture: renewal of existing fruit and wine plants,
berry plant and further landscape maintenance.

Standard version and characteristics

- > Mulches bushes and wood
up to 25 cm [9.8"]Ø

- > Working speed 0-5 km/h

- > 3 point rear linkage cat. 2
central fixed

- > 1000 rpm gearbox
with freewheel

- > Belt transmission

- > Hydraulically operated hood

- > Reinforced skids,
adjustable in height

- > Front- and rear protection with chains

- > Tempered counter knives

- > Standard rotor
with swinging hammers

Optional configuration and accessories

- > Swinging hammers with
3 tungsten carbide inserts

- > Combination of fixed hammers
with tungsten carbide inserts
MINI DUO and
MONO PROTECT EXTREME

- > Front attachment

- > 3 point rear linkage
cat. 1 and 2

- > 540 rpm gearbox

- > Centrifugal clutch

- > Guard frame

- > Rake hood

- > Support roller (instead of skids)



 www.youtube.com/seppimulcher

Specifications · MIDIFORST	Tractor 80-130 HP		
Working width	175 cm [69"]	200 cm [79"]	225 cm [89"]
Overall width	204 cm [80"]	229 cm [90"]	254 cm [100"]
Depth	112 cm [44"]	112 cm [44"]	112 cm [44"]
Height	120 cm [47"]	120 cm [47"]	120 cm [47"]
Weight (base value w/o options)	1.240 kg [2730lb]	1.360 kg [3000lb]	1.470 kg [3240lb]
Belts	5	5	5
Swinging hammers · standard	29	33	38
Swinging hammers · OPT-193	29	33	38
Fixed hammers · OPT-228 + lateral	38+2	42+2	46+2

Tools

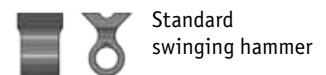

MIDIFORST · Characteristics

Compact strong forestry cutter for medium sized tractors with reinforced chassis, welded belt protection and lateral deflectors.



MIDIFORST dt

max. 30 cm Ø

120-190 HP

Strong compact forestry mulcher - the classic!

This forestry machine certainly 'punches above its weight' with its robust construction. With the swinging hammer rotor it is ideal for forestry mulching. For use as a forestry tiller the fixed hammers are the first choice. The patented rotor shaft and the hammers with additional tungsten carbide inserts make mulching and tilling very efficient. The patented tool holder system allow easy replacement of its hammers for minimum downtime.

Standard version and characteristics

- > Mulches bushes and wood up to 30 cm [11.8"]Ø
- > Working speed 0-5 km/h
- > 3 point rear linkage cat. 2 central fixed
- > 1000 rpm gearbox with freewheel
- > Dual side belt transmission
- > Hydraulically operated hood
- > Reinforced skids, adjustable in height
- > Front- and rear protection with chains
- > Tempered counter knives
- > Standard rotor with swinging hammers

Optional configuration and accessories

- > Swinging hammers with 3 tungsten carbide inserts
- > Combination of fixed hammers with tungsten carbide inserts MINI DUO and MONO PROTECT EXTREME
- > Combination of fixed hammers with tungsten carbide inserts MONO TIP V-LOCK and MONO PROTECT EXTREME
- > Front attachment
- > Hydraulic top link
- > ADAM™ Alignment system
- > Centrifugal clutch
- > Mechanical or hydraulic guard frame
- > Rake hood
- > Narrow skids



www.youtube.com/seppimulcher

Specifications · MIDIFORST dt	Tractor 120-190 HP		
	200 cm [79"]	225 cm [89"]	250 cm [98"]
Working width	200 cm [79"]	225 cm [89"]	250 cm [98"]
Overall width	233 cm [92"]	258 cm [102"]	283 cm [111"]
Depth	125 cm [49"]	125 cm [49"]	125 cm [49"]
Height	115 cm [45"]	115 cm [45"]	115 cm [45"]
Weight (base value w/o options)	1.590 kg [3510lb]	1.930 kg [4250lb]	2.150 kg [4740lb]
Belts	2x5	2x5	2x5
Swinging hammers · standard	33	38	42
Swinging hammers · OPT-193	33	38	42
Fixed hammers · OPT-228 + lateral	42+2	46+2	50+2
Fixed hammers · OPT-468 + lateral	61+2	68+2	75+2

Tools



Swinging hammer
STANDARD



Swinging hammer
OPT-193



Fixed hammer
OPT-228
MINI-DUO



Fixed hammer
OPT-468
MONO TIP V-LOCK



Lateral hammer
MONO PROTECT
EXTREME

MIDIFORST dt · Characteristics

Powerful mulcher for tractors between 120 - 190 HP.
with reinforced chassis, welded belt protection and lateral deflectors.
The machine is completely covered and protected; easy access due to the hatch for service and maintenance.

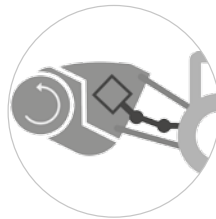

ADAM™ Alignment system
Angular adjustment protects the PTO shaft and the input shaft.
The range of movement is even greater. (option)

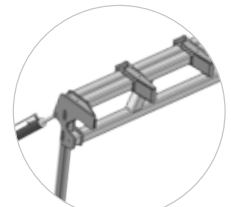

Guard frame for felling operations and to protect the tractor (option)

Machine interior completely covered, accessible via hatch

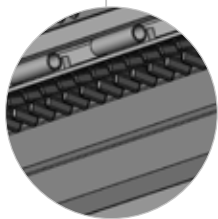

Reinforced chassis with wear-resistant steel plates
Tempered counter knives for a perfect mulching result



Lateral material deflectors with steel plates reinforced support skids

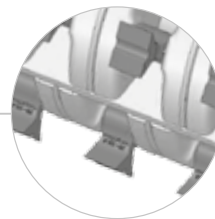

Rotor with swinging hammers for mulching grass and bushes/branches/wood



Rotor with fixed tools, for mulching wood and soil cultivation

STARFORST

max. 40 cm Ø 180-300 HP

Strong and manoeuvrable - highest performance with minimum weight

Strong: With the powerful Rotor and its hammers with inserts made of tungsten carbide STARFORST withstands powerful mulching & tilling operations.

Manoeuvrable: Thanks to the innovative 3-point linkage with automatic alignment, STARFORST is very mobile. With ADAM™ the forestry machine can be raised and lowered deeply for fast and easy tilling of stumps: locate the mulcher on the top of the stump and till it down in one operation - and all that remains is a heap of wood chips!

Standard version and characteristics

- > Mulches bushes and wood up to 40 cm [16"]Ø
- > Working speed 0-5 km/h
- > 3 point rear linkage cat. 3 central fixed
- > 1000 rpm gearbox with freewheel
- > ADAM™ alignment system
- > Dual side belt transmission
- > Hydraulically operated hood
- > Replaceable wear plates made of wear resistant steel AR400
- > Reinforced skids, adjustable in height
- > Front- and rear protection with chains
- > Tempered counter knives
- > Rotor with a combination of fixed hammers with tungsten carbide inserts MINI DUO and MONO PROTECT EXTREME

Optional configuration and accessories

- > Combination of fixed hammers with tungsten carbide inserts MONO TIP V-LOCK and MONO PROTECT EXTREME
- > Centrifugal clutch
- > Mechanical guard frame (various models available)
- > Hydraulic guard frame (various models available)
- > Narrow skids



[YouTube www.youtube.com/seppimulcher](https://www.youtube.com/seppimulcher)

NEW: Overall width adapted to road traffic regulations
⇒ for an optimal use of the working width

Specifications · STARFORST	Tractor 180-300 HP		
Working width	210 cm [83"]	235 cm [93"]	260 cm [102"]
Overall width	248 cm [98"]	273 cm [107"]	298 cm [117"]
Depth	137 cm [54"]	137 cm [54"]	137 cm [54"]
Height	125 cm [49"]	125 cm [49"]	125 cm [49"]
Weight (base value w/o options)	2.900 kg [6390lb]	3.140 kg [6920lb]	3.430 kg [7560lb]
Belts	2x5	2x5	2x5
Fixed hammers · OPT-228 + lateral	43+2	48+2	53+2
Fixed hammers · OPT-468 + lateral	61+2	68+2	75+2

Tools



Fixed hammer
MINI-DUO



Fixed hammer
OPT-468
MONO TIP V-LOCK



Lateral hammer
MONO PROTECT
EXTREME

ADAM™ alignment system

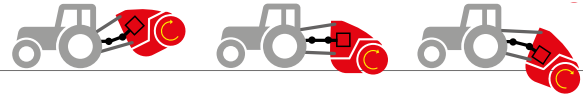

ADAM™ alignment system (standard feature)

Hydraulic tilting of the mulcher by gear tracking with PTO shaft alignment. With the W-shaped angles the range of motion increases and the mulcher can be moved up- and downwards even higher. This angular adjustment protects the PTO shaft and the input shaft even at high loads and supports an ideal adaptation to the conditions of the roads. Advantages: longer service life of PTO and input-shaft, even deeper digging, working with an hydraulic alignment system is easier and faster.



STARFORST

Powerful mulcher with robust chassis with internal replaceable plates made of high tensile and wear resistant steel. The machine is completely covered and protected; easy access due to the hatch for service and maintenance.

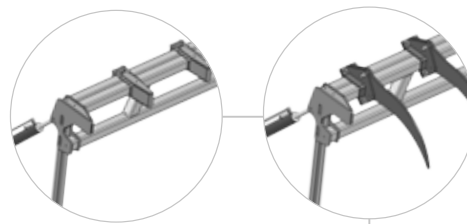

Guard frame for felling operations and to protect the tractor (option)

Machine interior completely covered, accessible via hatch

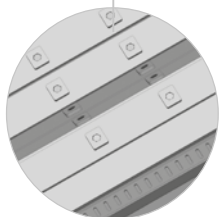

Chassis with internal replaceable plates made of AR400 hardened steel

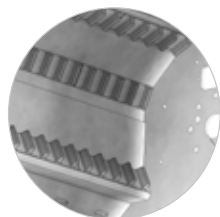

Tempered counter knives for a perfect mulching result

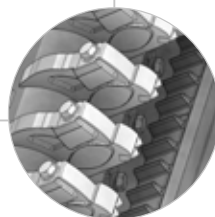

Rotor with fixed tools, for mulching wood and soil cultivation

Skids made of wear resistant steel

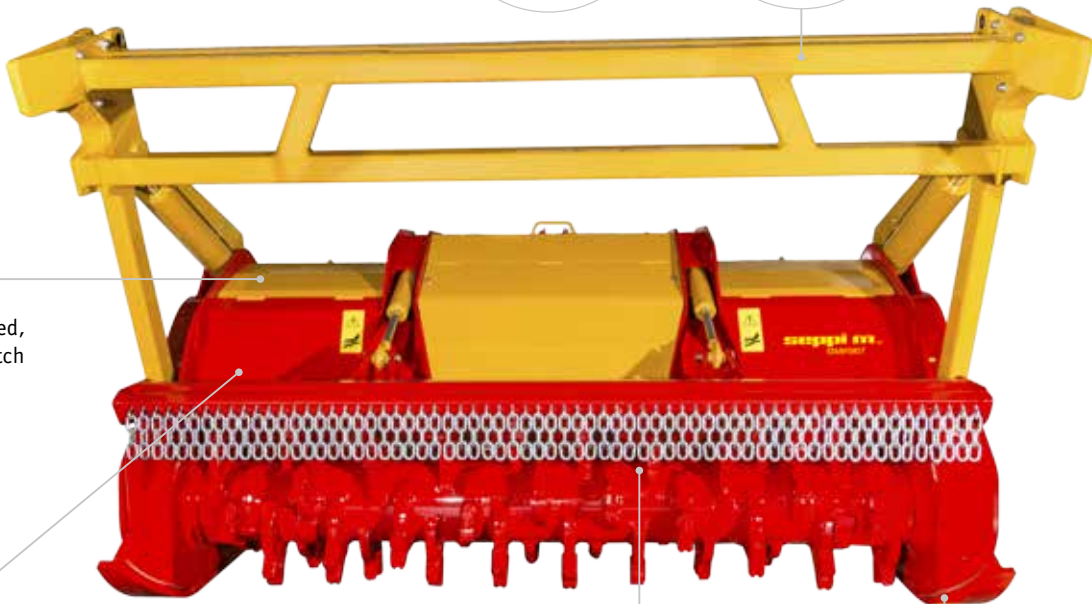

SUPERFORST

max. 50 cm Ø

230-390 HP

Powerful forestry mulcher for very high demands

Whether it is the maintenance of trees and wood land, cleaning up after cutting timber, after hurricanes or forest fires - those most demanding jobs are easy to manage for the powerful SUPERFORST.

Hammers with tungsten carbide inserts like the new SUPER TIP PROTECT mulch the strongest wood, a very robust chassis with wear protection ensures a long service life, - this forestry machine is a robust partner you can count on.

Standard version and characteristics

- > Mulches bushes and wood up to 50 cm [20"]Ø
- > Working speed 0-5 km/h
- > 3 point rear linkage cat. 3 central articulated
- > 1000 rpm gearbox with freewheel
- > ADAM™ alignment system
- > Dual side belt transmission
- > Hydraulically operated hood
- > Reinforced skids, adjustable in height
- > Front- and rear protection with chains
- > Tempered counter knives
- > Standard rotor fixed hammers MINI DUO with 2 tungsten carbide inserts

Optional configuration and accessories

- > Fixed hammers with 1+2 tungsten carbide inserts SUPER MONO TIP PROTECT
- > Front attachment
- > Hydraulic top link
- > Centrifugal clutch
- > Hydraulic guard frame (various models available)
- > Rakes on rear hood
- > Additional rear hood and reverse rotor drive



www.youtube.com/seppimulcher

Specifications · SUPERFORST	Tractor 230-390 HP		
Working width	200 cm [79"]	225 cm [89"]	250 cm [98"]
Overall width	244 cm [96"]	269 cm [106"]	294 cm [116"]
Depth	140 cm [55"]	140 cm [55"]	140 cm [55"]
Height	125 cm [49"]	125 cm [49"]	125 cm [49"]
Weight (base value w/o options)	3.800 kg [8380lb]	4.100 kg [9040lb]	4.400 kg [9700lb]
Belts	2x5	2x5	2x5
Fixed hammers · MINI DUO	42	48	54
Fixed hammers · OPT-452	x	80	

Tools



Fixed hammer
OPT-228
MINI-DUO



Fixed hammer
OPT-452 SUPER
MONO TIP PROTECT

ADAM™ alignment system

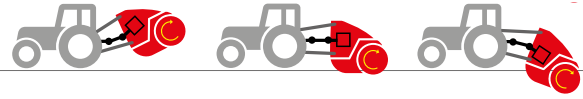

ADAM™ alignment system (standard feature)

Hydraulic tilting of the mulcher by gear tracking with PTO shaft alignment. With the W-shaped angles the range of motion increases and the mulcher can be moved up- and downwards even higher. This angular adjustment protects the PTO shaft and the input shaft even at high loads and supports an ideal adaptation to the conditions of the roads. Advantages: longer service life of PTO and input-shaft, even deeper digging, working with an hydraulic alignment system is easier and faster.



SUPERFORST

Powerful forestry tiller with a large rotor diameter, a reinforced chassis and additional material deflectors. The machine is completely covered and protected; easy access due to the hatch for service and maintenance.

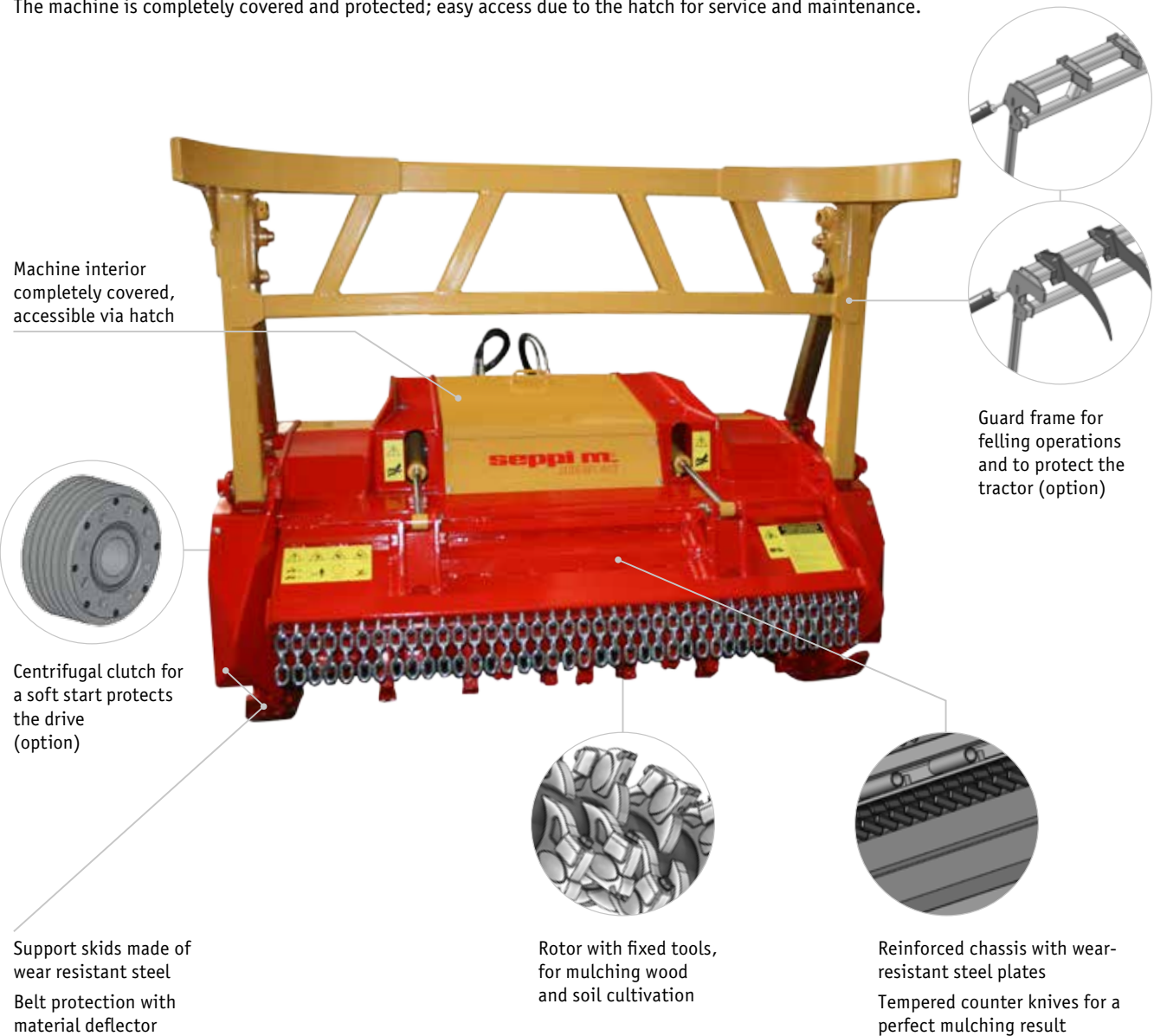

MAXIFORST

max. 60 cm Ø 300-500 HP

Powerful mulcher for uncompromising work under the toughest conditions

MAXIFORST takes on the most demanding jobs and handles every challenge. The particularly powerful machine and its powerful transmission with double drive mulches wood up to 60 cm in diameter. Whether it is the cleaning up after harvesting timber, maintenance of power lines or cleaning up after hurricanes or forest fires.

The integrated cooler ensures a constant performance.

Its special strength combined with robust material properties make MAXISOIL a strong partner for large projects.

Standard version and characteristics

- > Mulches wood up to 60 cm [24"] Ø
- > Working speed 0-5 km/h
- > 3 point rear linkage cat. 3 & 4 central fixed
- > 1000 rpm gearbox with freewheel, integrated cooling
- > ADAM™ alignment system
- > Dual side belt transmission
- > Centrifugal clutch
- > Hydraulically operated hood
- > Reinforced skids, adjustable in height
- > Front- and rear protection with chains
- > Tempered counter knives
- > Standard rotor with fixed hammers MINI DUO with 2 tungsten carbide inserts

Optional configuration and accessories

- > Combination of fixed hammers with tungsten carbide inserts MONO PROTECT und MONO EXTREME
- > Fixed hammers with tungsten carbide inserts SUPER MONO TIP
- > Hydraulic top link
- > Mechanical guard frame (various models available)
- > Hydraulic guard frame (various models available)
- > Rakes on rear hood



[YouTube www.youtube.com/seppimulcher](https://www.youtube.com/seppimulcher)

Specifications · MAXIFORST	Tractor 300-500 HP		
	250 cm [98"]	275 cm [108"]	300 cm [118"]
Working width	250 cm [98"]	275 cm [108"]	300 cm [118"]
Overall width	300 cm [118"]	325 cm [118"]	350 cm [118"]
Depth	150 cm [59"]	150 cm [59"]	150 cm [59"]
Height	150 cm [59"]	150 cm [59"]	150 cm [59"]
Weight (base value w/o options)	4.330 kg [9550lb]	4.580 kg [10100lb]	4.960 kg [10930lb]
Belts	2x6	2x6	2x6
Fixed hammers · standard	54	60	66
Fixed hammers · OPT-141 + lateral	52+2	58+2	64+2

Tools



Fixed hammer
MINI-DUO



Fixed hammer
OPT-141
MONO PROTECT



Lateral hammer
MONO PROTECT
EXTREME

ADAM™ alignment system

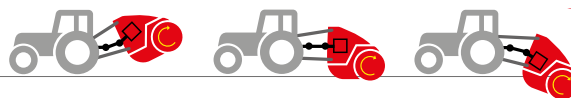

ADAM™ alignment system (standard feature)

Hydraulic tilting of the mulcher by gear tracking with PTO shaft alignment. With the W-shaped angles the range of motion increases and the mulcher can be moved up- and downwards even higher. This angular adjustment protects the PTO shaft and the input shaft even at high loads and supports an ideal adaptation to the conditions of the roads. Advantages: longer service life of PTO and input-shaft, even deeper digging, working with an hydraulic alignment system is easier and faster.



video ADAM™

MAXIFORST

High performance forestry tiller with a large rotor diameter, a reinforced chassis and additional material deflectors. The machine is completely covered and protected; easy access due to the hatch for service and maintenance.

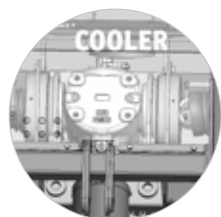

Powerful transmission with double belt drive - integrated cooling



Centrifugal clutch for a soft start protects the drive (standard)

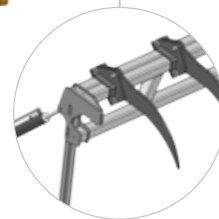
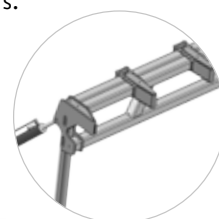

Guard frame for felling operations and to protect the tractor (option)

Belt protection with material deflector

Support skids made of wear resistant steel

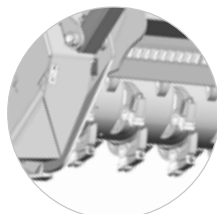

Exposed position of the rotor for an easy grip to the material

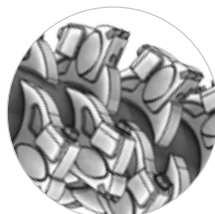

Rotor with fixed tools, for mulching wood and soil cultivation

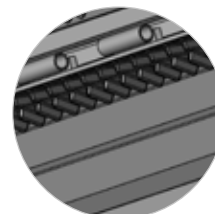

Reinforced chassis with wear-resistant steel plates
Tempered counter knives for a perfect mulching result

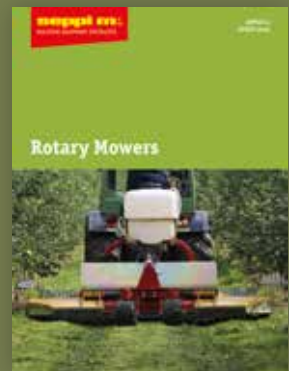
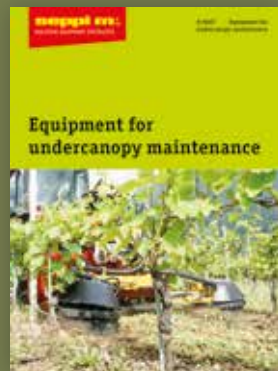
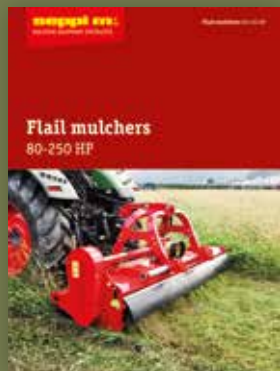
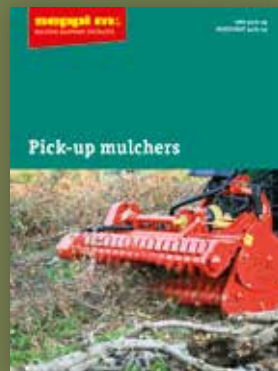
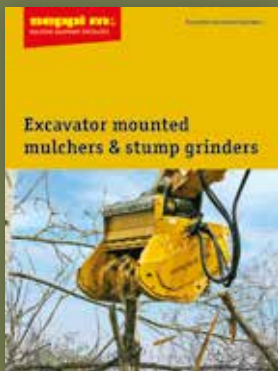
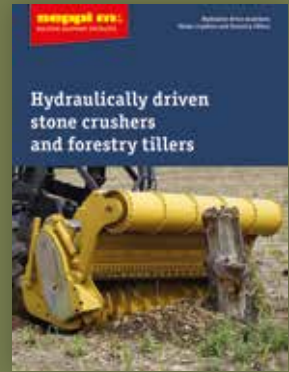
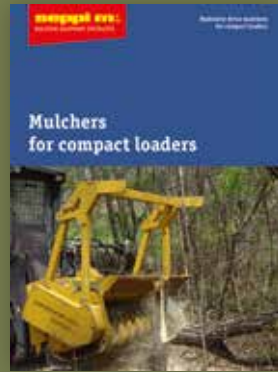
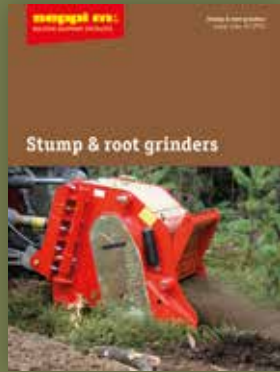
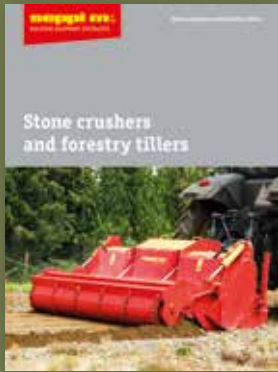

SEPPI M. SpA/AG Italy
 Zona Artigianale 1 Handwerkerzone
 I-39052 Caldaro/Kaltern (BZ)
 T. +39 0471 963 550 · www.seppi.com



www.youtube.com/seppimulcher

